



U-BRACKET ASSEMBLY – FIBER OPTIC

Features:

- Pre-aligned fiber launch and re-collect
- Available in single mode, polarization maintaining and multimode versions
- Low insertion loss
- High PER for PM applications
- Compact housing or wide free-space air-gap
- Wide beam sizes available

Applications:

- Sample interrogation
- Prototyping pigtailed optical devices
- Polarization control
- Filters
- Spectroscopy

Fiber optic U-bracket assemblies are designed to transmit light from an optical fiber, across an air gap, and back into a second fiber with low losses. The U-bracket is prealigned at the factory for minimum insertion losses, making it very easy to use. A variety of bulk optical devices, including polarizers, isolators, filters, and waveplates, can be simply inserted into the U-bracket, allowing the user to quickly and easily test or prototype systems incorporating fiber and bulk optics.

The U-Bracket assembly consists of three parts: an input fiber collimator, the U-bracket itself, and an output fiber focuser. Utilizing OZ Optics' patented tilt adjustment technique, losses of only 0.6 dB are achieved across a 60mm gap for pigtailed singlemode fibers, with backreflection levels of -25dB, -40dB or -60 dB available. Connector style assemblies are also available for a variety of connectors, including NTT-FC, AT&T-ST, bare fiber adapters, etc. Typical insertion losses are 1.0 dB across a 60mm gap for connectorized versions, with backreflection levels typically -20 dB.

U-Brackets are available in different sizes, with different gap spacings according to the customer's needs. Many different custom designs can be made for your application. For instance, source to fiber versions are available, where light from either a laser, a laser diode, or an LED is transmitted across the air gap and into the output fiber. Another option is to have a photo detector attached to the output end of the U-bracket, to measure the transmitted light. Another device available is a black box with a removable filter holder, to quickly insert and remove a filter from the optical path. Contact OZ for further information.

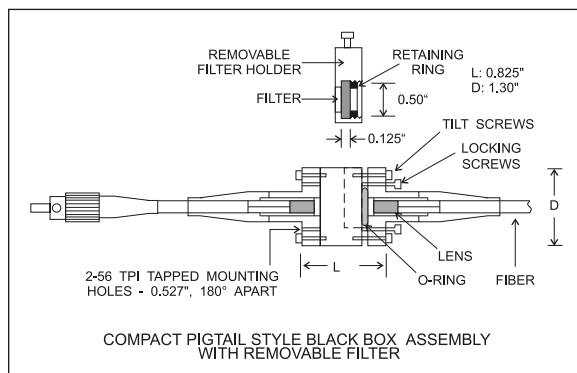
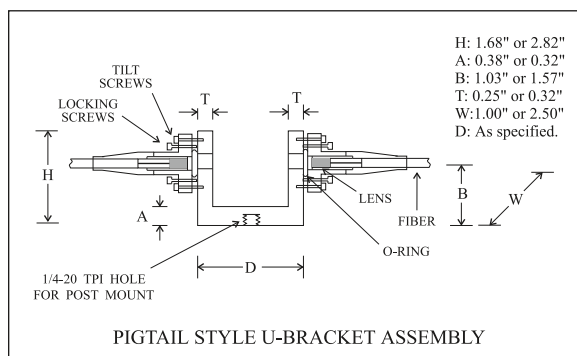
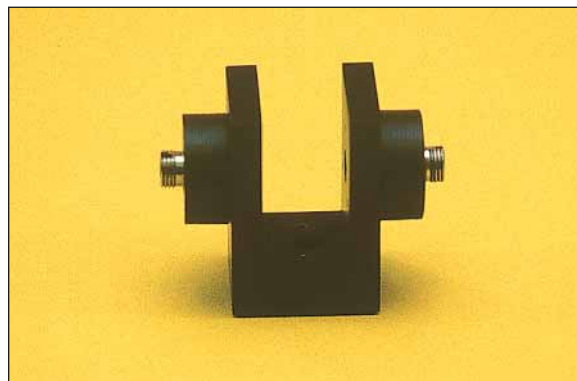

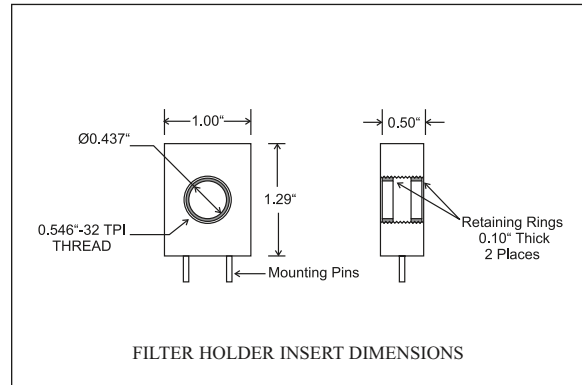
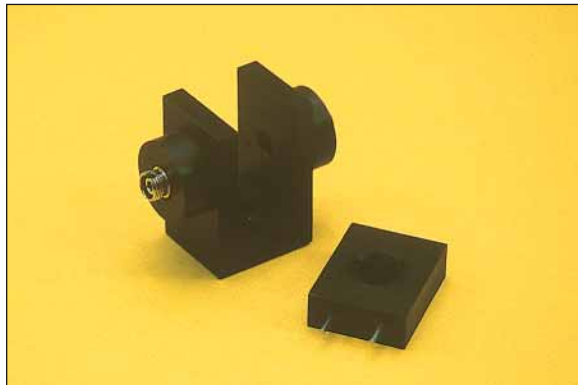
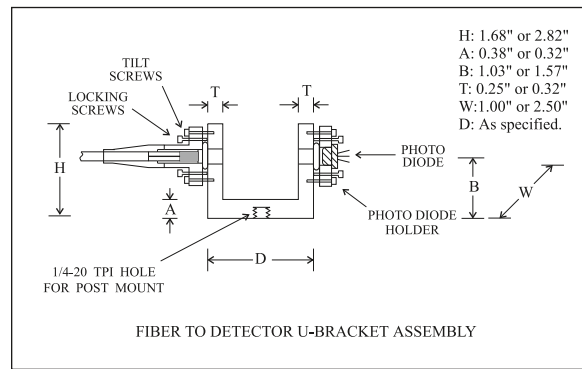
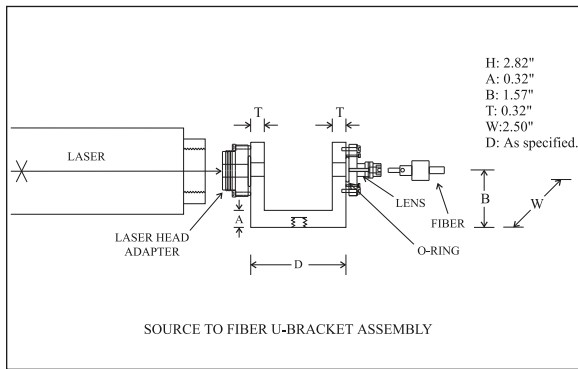

ORDERING INFORMATION

Pigtail style U-Bracket assembly with low backreflection

UB-1A-11-W-a/b-I-O-D-LB-XY-JD-L

A = is the size of the U-Bracket; 1 for large body (H=2.82", W=2.5", A=0.32", B=1.57", T=0.32"), 2 for small body (H= 1.68", W=1.0", A=0.38", B=1.03", T=0.25"). Custom size U-Bracket Assemblies are available on request.

W = is the operating wavelength in nm.

a.b = are the fiber core and cladding sizes, respectively, in microns.

I.O = are the input and output fiber types (S for singlemode, M for multimode, P for polarization maintaining fibers).

D = is the length of the U-Bracket body in inches. (Standard sizes include D=1.85", D=3.03" for large body U-Brackets, D=1.15" or 1.80" for small body U-Brackets).

L = is the fiber length in meters.

JD = is the fiber jacket type (1 for uncabled fiber, 3 for 3mm OD loose tube Kevlar, 3A for 3mm OD armored cable, and 5A for 5mm armored cable).

XY = are the input and output connector receptacle types for connector style U-Brackets. For pigtail style U-Brackets they refer to the male connectors on the fiber ends (3 for NTT-FC, 5 for SMA 905, 8 for AT&T-ST, SC for SC connectors, X for unterminated fibers, etc.).

LB = is the desired backreflection level (25dB, 40dB, or 60dB for pigtail style systems).

Please see our *Standard Tables* data sheet
http://www.ozoptics.com/ALLNEW_PDF/DTS0079.pdf

Part Number	Description
UB-INSERT-01-0.5	0.5" OD Filter holder insert for small U-bracket UB-12, UB-02 style assemblies.

ORDERING INFORMATION *continued*

U-Bracket assembly with female connector receptacles

UB-0A-XY-W-I-O-D

A = is the size of the U-Bracket; 1 for large body (H=2.82", W=2.5", A=0.32", B=1.57", T=0.32"), 2 for small body (H= 1.68", W=1.0", A=0.38", B=1.03", T=0.25"). Custom size U-Bracket Assemblies are available on request.

X,Y = are the input and output connector receptacle types for connector style U-Brackets. For pigtail style U-Brackets they refer to the male connectors on the fiber ends (3 for NTT-FC, 5 for SMA 905, 8 for AT&T-ST, SC for SC connectors, X for unterminated fibers, etc.).

D = is the length of the U-Bracket body in inches. (Standard sizes include D=1.85", D=3.03" for large body U-Brackets, D=1.15" or 1.80" for small body U-Brackets).

I,O = are the input and output fiber types (S for singlemode, M for multimode, P for polarization maintaining fibers).

W = is the operating wavelength in nm.

Please see our *Standard Tables* data sheet
http://www.ozoptics.com/ALLNEW_PDF/DTS0079.pdf

Ordering example for custom parts

A customer wants to use a pigtail style U-Bracket for 1300nm fiber, with 40dB backreflection. The input side is polarization maintaining fiber, while the output side is singlemode fiber. Both fibers are one meter long, cabled with 3.0mm Kevlar cable, and terminated with male NTT-FC connectors. The small body size U-bracket with the 1.15 inch body length is to be used. OZ Optics' part number: **UB-12-11-1300-9/125-P-S-1.15-40-33-3.0-1**.



光技術をサポートする

株式会社オプトサイエンス

<http://www.optoscience.com>

東京本社 〒160-0014 東京都新宿区内藤町1番地 内藤町ビルディング TEL:03-3356-1064
大阪支店 〒532-0011 大阪市淀川区西中島7-7-2 新大阪ビル西館 TEL:06-6305-2064
名古屋営業所 〒450-0002 名古屋市中村区名駅2-37-21 東海ソフトビル TEL:052-569-6064

E-mail: info@optoscience.com